

 **BEKAERT**

better together

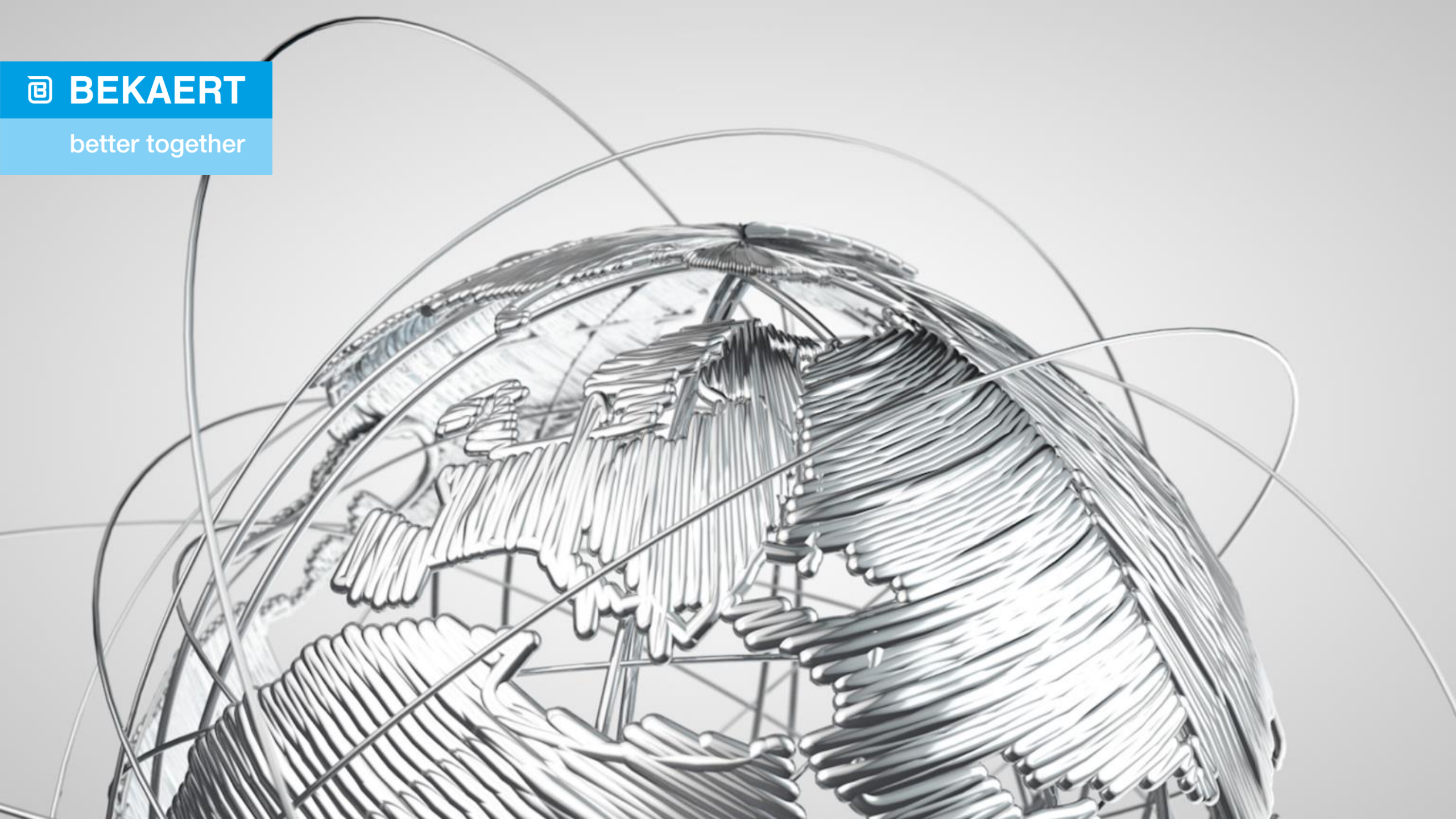



Architectural and artistic freedom for plasterwork



Are you looking for (new) **architectural** possibilities for your next project?

Plastering & retrofit solutions opens up new architectural and artistic finishing options for both interior and exterior plasterwork and rendering. It gives the designer or architect total freedom in the creation of designs for new buildings or renovation projects:



- ✓ Arches
- ✓ Slanted walls
- ✓ Floating ceilings
- ✓ Trusses
- ✓ Decorative three-dimensional applications
- ✓ Internal or external walls

Plastering/rendering without reinforcement:

- weak in tension
- brittle
- sensitive for cracks
- Limited creative possibilities in terms of shapes



Plastering/rendering with reinforcement:

- more strength and resistance
- control of cracks:
multiple, non-visible micro cracks
instead of one wide vertical
- More creative possibilities in terms of shapes



Principle of plaster/render reinforcement

Temperature changes and other environmental situations can affect your plaster/renderwork, leading to movement and cracking. **To avoid cracking** it is important to add qualitative reinforcement to your interior and exterior plastering/rendering walls and shapes

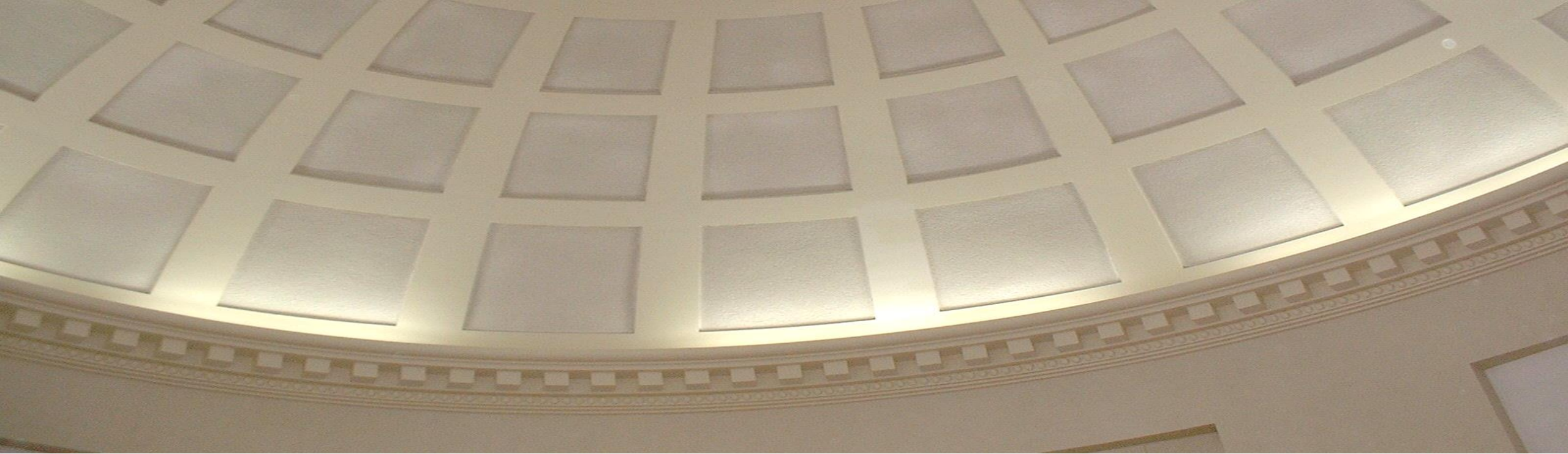

To avoid plastering/rendering cracking it is important to add qualitative plastering/rendering reinforcement to your wall.

Were to apply plastering/rendering reinforcement?

Inside applications:

- ✓ Arches
- ✓ Slanted walls
- ✓ Floating ceilings
- ✓ Trusses
- ✓ Decorative three-dimensional applications

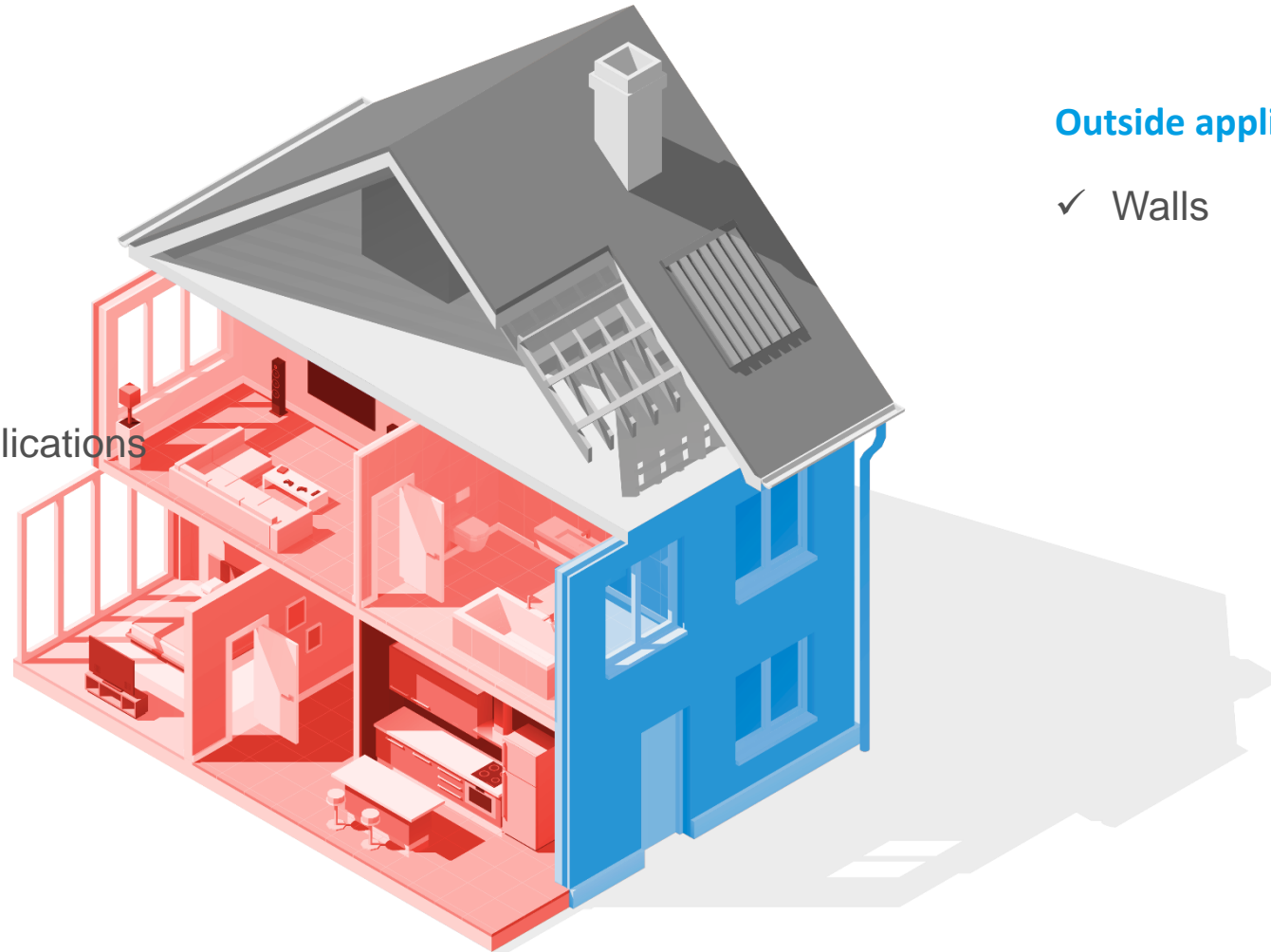

Outside applications:

- ✓ Walls

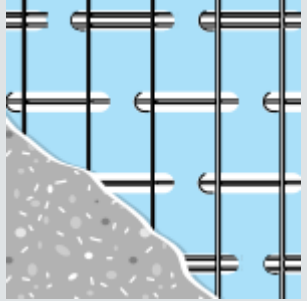

Stucanet

Lath for plaster and renders

For walls and ceilings,
housing and sculptures

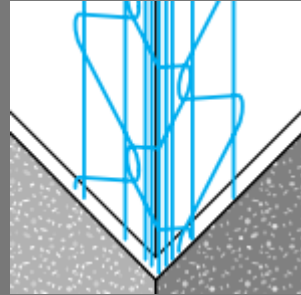

Widra

Corner-beads

Galvanised steel-wire profiles for
inside and outside rendering.

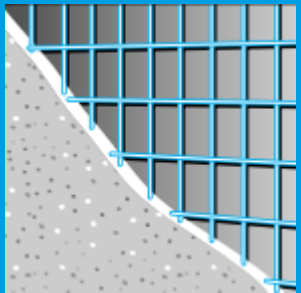

Armanet

Render & plaster reinforcing mesh

A heavily galvanized welded mesh used for
interior and exterior plastering and rendering.

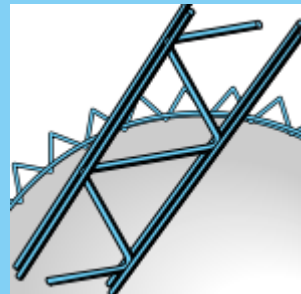

Poutrafil

Wire-studs

For light weight, yet strong walls and ceilings.
Also can be used for lighting gentries, trade
fairs, office and shop fitting.

We offer **4 plaster and retrofit solutions** to fit the most challenging project needs

Stucanet

The solution for perfect and durable plasterwork and rendering

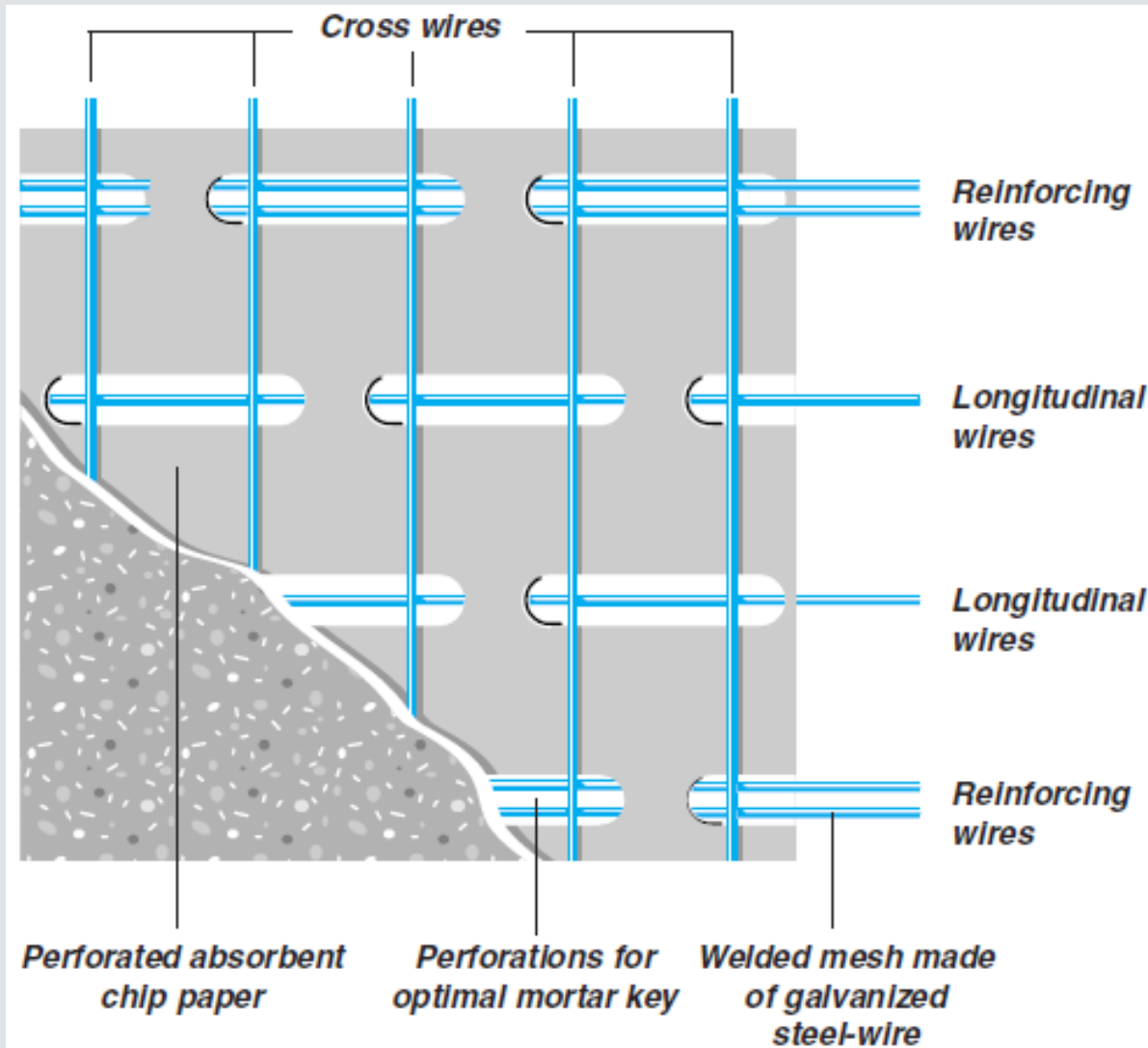

Stucanet, the perfect lath for plaster and renders

Stucanet® is a panel made from a [galvanized or stainless steel welded wire mesh](#) into which a moisture absorbent sheet of chip paper is interwoven. The chip paper assists with the wet adhesion and curing of the mortar and the perforations allow the mortar to perfectly bond around the steel wires, resulting in firm anchoring of the mortar.

Stucanet is well suited for all types of plastering

- ✓ Using either with lime-cement mortars or cement-mortars.
- ✓ When applying Stucanet® on **outside walls**, it is also possible to use lime-sand-cement mortars.





Benefits of Stucanet

Extremely strong

Stucanet is both **light** and **strong**. The panels are made up of welded low carbon steel wires with outstanding tensile strength and zinc protection.

Excellent bonding thanks to perforations

The perforations in the moisture absorbent chip paper allow **optimal bonding of the mortar** around the steel wires, thereby ensuring excellent mechanical anchoring.

Durable, also in exterior applications

In exterior applications, Stucanet is less sensitive to thermal expansion and temperature variations than expanded metal lathing, thanks to its wire structure. It offers **better protection against tears and cracks** in façade and exterior plasterwork in general.

The solution for perfect and durable plasterwork and rendering



The bonding of the mortar around the steel wires ensures **firm anchoring**.



The substrate in renovation projects often consists of a mix of different building materials. Stucanet allows the **durable renovation and plastering** of this type of difficult walls.



Stucanet as **mortar support** in a façade insulation system, mounted on metal Poutrafil profiles.



Stucanet applied in a façade renovation project with **exterior plasterwork**.



Quick and easy installation on every substrate or supporting structure

Flexible panels for convenient use

Stucanet panels are light and flexible, and therefore easy to move, also on hard-to-reach areas. Stucanet is also easy to cut, bend and fix, thereby ensuring smooth and fast processing.

Both on level substrates and on supporting structures

Stucanet is easy to install, both on solid substrates (masonry or concrete) and on supporting structures (timber frame or metal profiles) using commercially available plugs, screws, hooks or clips.

Both manual and mechanical plastering

Stucanet can be plastered and rendered both manually or mechanically. Typically, a total layer thickness of 20 mm is used.

Types of Stucanet

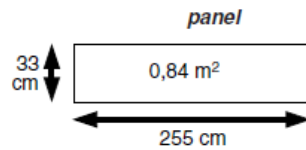
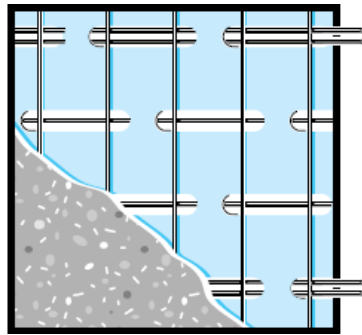

Stucanet 33

- ✓ **2 parallel wires** for fixing
- ✓ Panel size 33 x 255 cm
- ✓ Upon request, available in stainless steel (AISI304)

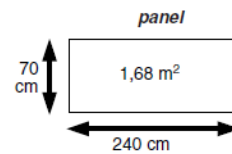
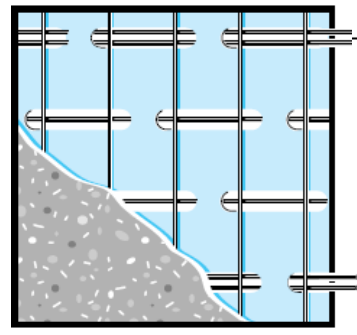

Stucanet S



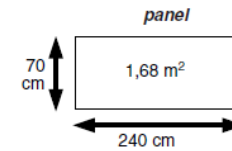
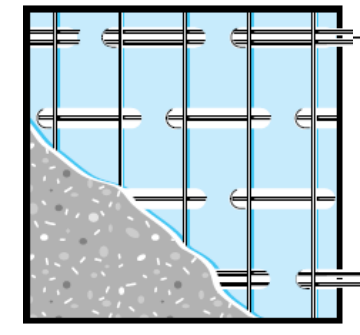





- ✓ **2 parallel wires** for fixing
- ✓ Panel size 70 x 240 cm
- ✓ Also available with waterproof bitumen paper (Stucanet® S-H)
- ✓ Upon request, available in stainless steel (AISI304)



Stucanet 80

- ✓ **Flat wire** for fixing
- ✓ Panel size 70 x 240 cm
- ✓ Upon request, available in stainless steel (AISI304)

Technical data wires

Stucanet®	33	S	80	S-H Bitumen
Longitudinal and cross wires	 1,50 mm	 1,50 mm	 1,50 mm	 1,50 mm
Reinforcing wires	 1,50 mm	 1,50/2,00 mm	 6,00 x 2,0 mm	 1,50/2,00 mm
Number of reinforcing wires	—	—	5	-
Meshes (mm)	38 x 50	38 x 50	38 x 50	38 x 50
Sidemeshes (mm)	38 x 27	38 x 27	38 x 27	38 x 27
Tensile strength - N/mm ²	for all types : min. 350 N/mm ²			
Zinc coating- gr/m ²	diameter 1,50 en 2,00 mm : min 60 g/m ² diameter 6 x 2 mm : min 50 gr/m ²			

Technical data panels

Stucanet®	33	S	80	S-H Bitume
panel (m)	2.55 x 0.33	2.4 x 0.7	2.4 x 0.7	2.4 x 0.7
m ² /panel	0.84	1.68	1.68	1.68
kg/panel	0.80	1.78	2.5	2.05
kg/m ²	0.57	1.06	1.47	1.22
packing: panels per bundle	15	15	15	10
printing		gray	gray	gray

Weight cardboard: all types min. 300 gr/m²

Installation guidelines

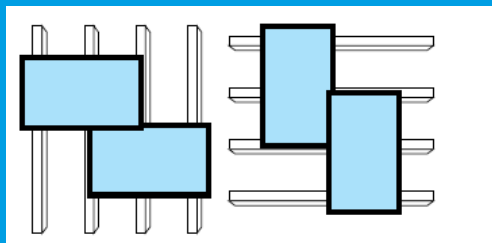

Always apply the panels **perpendicular** to the supports

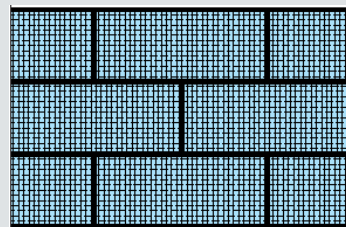

Always apply the panels in **staggered pattern**

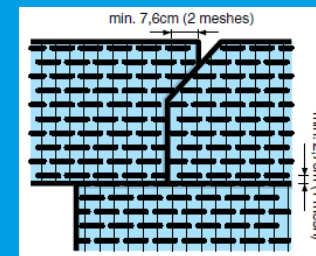

Overlap minimum 2 meshes (7,6 cm) on short edge and minimum 1 mesh on long edge of the panel. Remove the paper where the panels overlap.

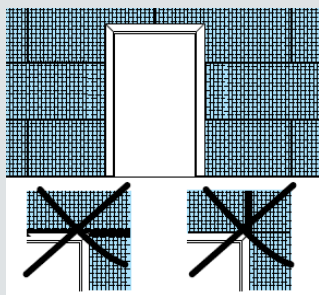

Avoid panels overlapping along the lines of **doors and windows**

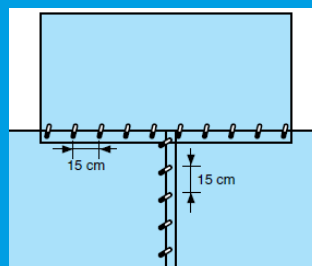

Wire tie the panels together every 15 cm

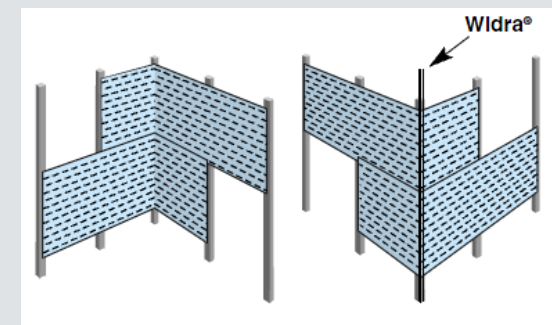

At **corners** a full panel should be fixed on to the support. Use Widra® corner beads to reinforce the corners

Plastering guidelines



Stucanet® can be plastered either **by hand** or **mechanically**.

The **first layer of mortar** will fill the holes in the slot-perforated absorbent paper and fix itself around the wires



To assure a solid key with the top coat, this layer must be **combed** before hardening.



The **second coat** enables a smooth surface and should provide the thickness required.

A minimum thickness of 20 mm should be applied for ceilings and walls.
Top layer should be 10 mm minimum

Fixing guidelines

Wooden frame

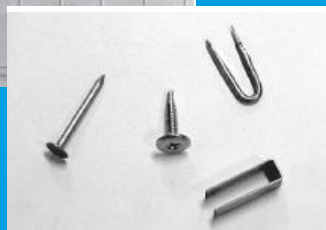

C-profile

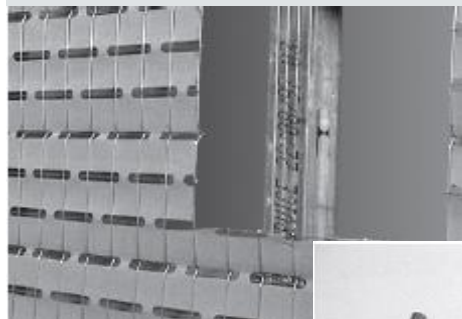

IPE-profile

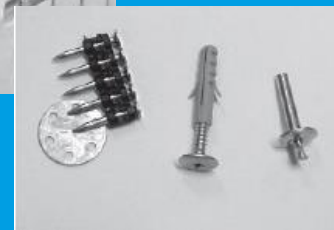

Concrete

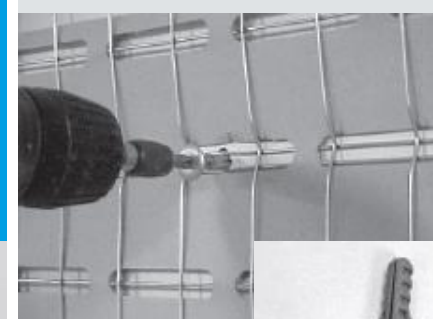

References



Interior plastering

Bellagio hotel Las Vegas, US

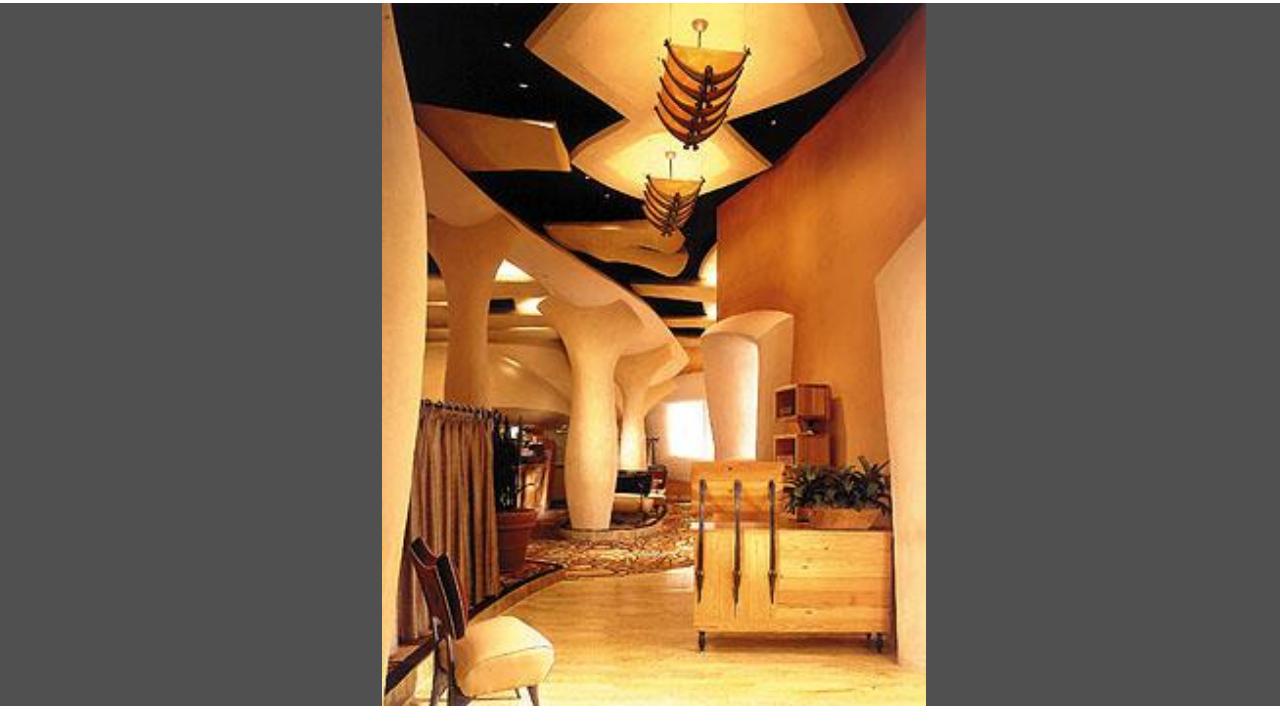



Exterior plastering

Quai Branly museum, Paris, France





Interior plastering

Louvre museum, Paris, France





Aula Leipzig, Germany

- Approx 20.000m² suspended ceiling in dome shapes
- 4 cm render thickness in total (2,5 cm base coat)
- More than 35m without movement joints
- Domes are designed to be self-supporting on pillars, support structure with steelcords (Würth) for extra safety
- Dome structure (Poutrafil, Stucanet and extra supports) built in 4 months





Outside plastering

Holzrahmenbau Schacht,
Germany





Interior plastering

East-hotel Hamburg, Germany



Interior plastering

Festhalle Frankfurt, Germany





Interior plastering

Coffee bar Wiesbaden, Germany





Internal plastering

Russian Orthodox church Paris,
France

Realization of 5 domes





Holy family



Holy Family Catholic
Church Wanaka
copyright Sarah Scott Architects Ltd

Widra

The solution to reinforce corner-beads

Widra® corner beads are used to form straight or round corners when rendering or plastering. Widra® corner beads can be embedded in cement-mortar, lime-cement, mortar or plaster and can be used with Stucanet® or Armanet®. The galvanized or stainless steel wire Widra® corner beads are available with or without PVC-nosing.

Widra corner-beads are made from galvanized or stainless steel-wire and are used to form straight corners when plastering.

Widra corner-beads can be embedded in cement-mortar, lime-cement, mortar or plaster.



Benefits of Widra

- ✓ Quick and accurate finishing at corners
- ✓ Open steel wire construction allows render/mortar to fully key behind the beads
- ✓ Strong reinforcement for exposed corners
- ✓ Available in different shapes and finishes for excellent corrosion resistance
- ✓ Corrosion resistance.

internal plastering:	• plaster	: Widra® IP
external rendering:	• lime-cement mortar • cement mortar	: Widra® AP-types with or without PVC-jonc

Installation guidelines

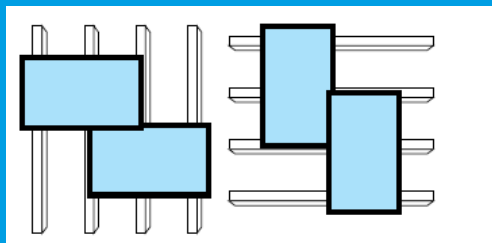

Always apply the panels **perpendicular** to the supports

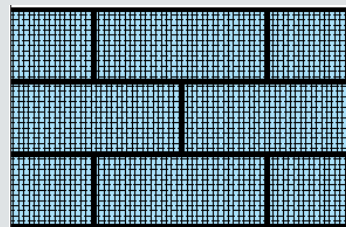

Always apply the panels in **staggered pattern**

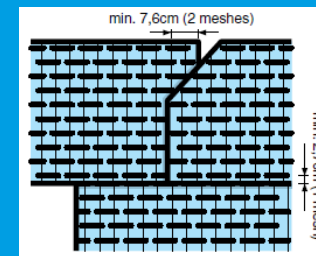

Overlap minimum 2 meshes (7,6 cm) on short edge and minimum 1 mesh on long edge of the panel. Remove the paper where the panels overlap.

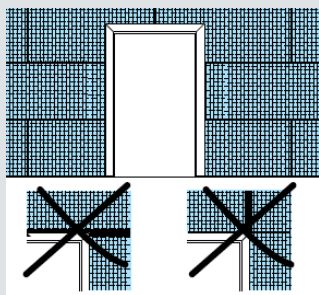

Avoid panels overlapping along the lines of **doors and windows**

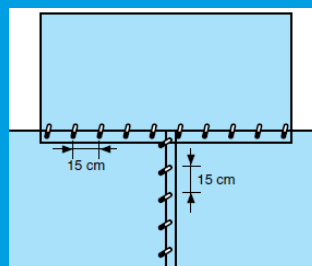

Wire tie the panels together every 15 cm

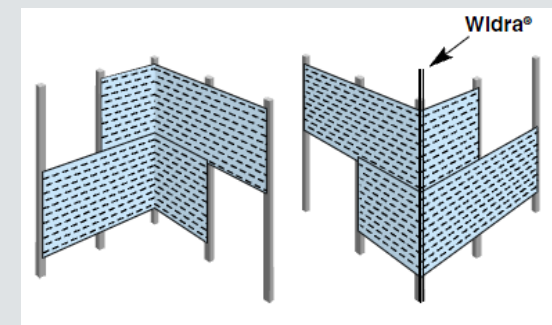

At **corners** a full panel should be fixed on to the support. Use Widra® corner beads to reinforce the corners

Installation guidelines

The corner-beads are fixed into the correct position using the plaster. The profile is pressed into this mortar and straightened. After hardening, the corner can be plastered.

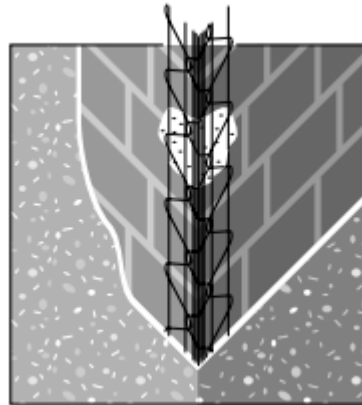

Poutrafil

Wire-studs

Armanet

Render & plaster reinforcing mesh

Armanet® is a reinforcing mesh for the renovation of cracked walls, and can also be used as a render support for insulation systems. It can be used in both interior and exterior plastering and rendering.

Armanet® is a welded wire mesh from galvanized (galvanized after welding) or stainless steel wire. Armanet® is supplied in rolls or in panels. Alternatively, it can be supplied with indentations at regular intervals that act as spacers.

Advantages

- Quick and easy installation on every substrate or supporting structure
- The solution for perfect and durable plastering and rendering
- Prevents problems of crack formation

Sheraton - Airporthotel

TYPE OF APPLICATION: renovation frontside

LOCATION: Frankfurt/Germany

DATE OF CONSTRUCTION: april 2007

ENGINEER/ARCHITECT:

CONTRACTOR/PLASTERER: Schwenk - Putz



Sheraton - Airporthotel

Description of the project

Armanet reinforcing mesh was requested to make a new frontside. Different undergrounds with non adhesive surfaces had to be protected with Armanet, that the new plaster could get a fixation.



Armanet protection on bad undergrounds

Solution with Bekaert Plastering Products

Type of product:

Armanet 12,7

Type of application:

covering the complete front

Type of plaster:

trass - plaster Schwenk

Project size:

1200m²

infobuilding@bekaert.com
www.bekaert.com/building

LOCATION: Cologne/Germany

DATE OF CONSTRUCTION: april 2010

ENGINEER/ARCHITECT:

CONTRACTOR: Cesmo Berlin



reinforcement for cooling/heating ceilings with dowels type AD

Description of the project

All ceilings were executed with heating/cooling tubes. The tubes had to be reinforced with Armanet® that plaster, tubes and subground ceiling could get a strong connection to avoid cracks coming from temperature differences.



office area in Köln/Germany with 6 floors

© 2008 Bekaert

Solution with Bekaert Building Products

Type of product:

Armanet®

Type of application:

reinforcement

Project size:

23 000 m²

infobuilding@bekaert.com
www.bekaert.com/building

EKAERT

better together

We deliver **value-added solutions for construction**

- ✓ Developing **durable and easy-to-install solutions** with a focus on better materials, greater safety, stronger constructions and lower cost is the ambition we share with the building sector. Our solid reputation is built on proven technologies and smart designs.
- ✓ **Experienced people**
Our highly qualified sales professionals have a wide range of experience and will guide and support you through a job.
- ✓ **How can we help you?**

Thank you!

[www.bekaert.com/
murfor](http://www.bekaert.com/murfor)

 **BEKAERT**

better together